



evoDESK

Torrette estraibili in Alluminio

Aluminium pop-up turrets



Caratteristiche Tecniche Technical Features

- Profilo in Alluminio ed accessori in Poliammide
- Trunking of Aluminium and accessories of Polyamide
- Resistenza all'urto IK 08 (5J)
- Mechanical protection IK 08 (5J)
- Grado di protezione IP40
- Protection degree IP40

Caratteristiche di Impiego Use Features

- Torretta a scomparsa adatta per applicazioni su scrivanie, cucine, sale conferenza e mobili
- Vanish electrified module in aluminium suitable for use on desks, kitchens, conference rooms and furnitures

Riferimenti a Norme Norms Reference

- La linea è conforme alla norma DIN 0620-1/02.2010
- The system complied to DIN VDE 0620-1/02.2010
- La linea è conforme alla Direttiva Rohs 2 2015/863/EU
- The system complied to Rohs 2 2015/863/EU
- La linea è conforme alla Direttiva B.T. 2009/95/CE
- The system complied to L.V.D. 2009/95/CE





Marchi e Certificazioni Marks and certifications

- Marchio VDE riferimento n° S 60030068
- Mark VDE reference n° S 60030068
- Marcatura CE
- CE Marking



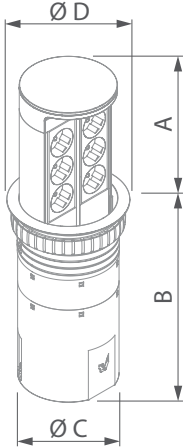

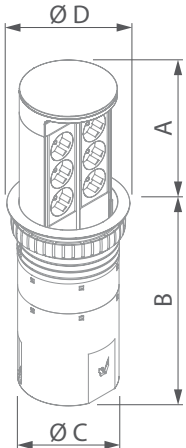
Colori disponibili Available colours

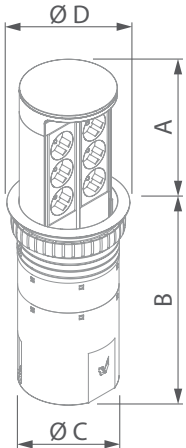
- Alluminio anodizzato NERO o BIANCO
- BLACK or WHITE anodized aluminium

Torrette estraibili elettrificate, in ALLUMINIO (versioni standard)
Wired pop-up turret, of ALUMINIUM (standard versions)

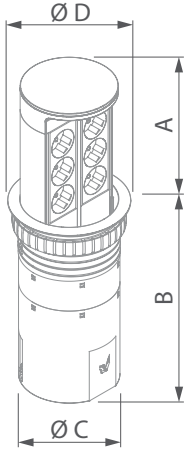
Articolo Item		Descrizione Description	A mm	B mm	C Ø mm	D Ø mm
M104.4B.N	M104.4B.A3	M104.4B.N Torretta alluminio NERO, accessori plastica nera	220	255	125	165
		M104.4B.A3 Torretta alluminio BIANCO, accessori plastica bianca Cablate con 4 MULTI-prese (4 Schuko/8 bipasso) cavo di alimentazione lunghezza 2 metri				
M104.4S.N	M104.4S.A3	M104.4S.N Torretta alluminio NERO, accessori plastica nera	220	255	125	165
		M104.4S.A3 Torretta alluminio BIANCO, accessori plastica bianca Cablate con 3 MULTI-prese e 2 prese di carica USB 2.4A cavo di alimentazione lunghezza 2 metri				
M104.4U.N	M104.4U.A3	M104.4U.N Torretta alluminio NERO, accessori plastica nera	220	255	125	165
		M104.4U.A3 Torretta alluminio BIANCO, accessori plastica bianca Cablate con 2 MULTI-prese, 2 prese di carica USB 2.4A e 2 prese RJ45 cat6, cavo di alimentazione lunghezza 2 metri				
		M104.4U.N BLACK aluminium turret, black plastic accessories				
		M104.4U.A3 WHITE aluminium turret, white plastic accessories				
		Wired with 2 MULTI-sockets, 2 USB sockets 2.4A and 2 RJ45 sockets cat6, power cable length 2 meters				

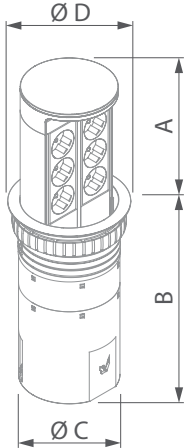

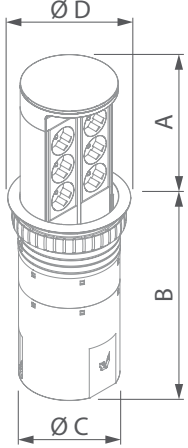
Torrette estraibili elettrificate, in ALLUMINIO (versioni standard)
Wired pop-up turret, of ALUMINIUM (standard versions)

Articolo Item		Descrizione Description	A mm	B mm	C Ø mm	D Ø mm
M104.4R.N	M104.4R.A3	M104.4R.N Torretta alluminio NERO, accessori plastica nera	220	255	125	165
		M104.4R.A3 Torretta alluminio BIANCO, accessori plastica bianca Cablata con 3 MULTI-prese e 2 prese RJ45 cat6 cavo di alimentazione lunghezza 2 metri M104.4R.N BLACK aluminium turret, black plastic accessories M104.4R.A3 WHITE aluminium turret, white plastic accessories Wired with 3 MULTI-sockets and 2 RJ45 sockets cat6 power cable length 2 meters				
M102.4S.N	M102.4S.A3	M102.4S.N Torretta alluminio NERO, accessori plastica nera	180	215	125	165
		M102.4S.A3 Torretta alluminio BIANCO, accessori plastica bianca Cablata con 1 MULTI-presa, 2 prese di carica USB 2.4A e 1 presa bipasso, cavo di alimentazione lunghezza 2 metri M102.4S.N BLACK aluminium turret, black plastic accessories M102.4S.A3 WHITE aluminium turret, white plastic accessories Wired with 1 MULTI-socket, 2 USB sockets 2.4A and 1 bipasso socket, power cable length 2 meters				
M104.4L.N	M104.4L.A3	M104.4L.N Torretta alluminio NERO, accessori plastica nera	220	255	125	165
		M104.4L.A3 Torretta alluminio BIANCO, accessori plastica bianca Cablata con 3 MULTI-prese, 2 prese di carica USB 2.4A, 1 interruttore 2 poli, illuminazione LED interna, cavo di alimentazione lunghezza 2 metri M104.4L.N BLACK aluminium turret, black plastic accessories M104.4L.A3 WHITE aluminium turret, white plastic accessories Wired with 3 MULTI-sockets, 2 USB sockets 2.4A, 1 switch 2 poles, internal LED light, power cable length 2 meters				

On request are available turrets with different dimensions and layouts from the standard

Torrette estraibili elettrificabili, in ALLUMINIO (versioni standard)

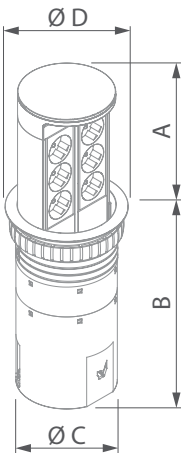
Wiring pop-up turret, of ALUMINIUM (standard versions)

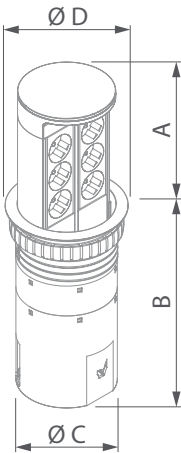
Articolo Item		Descrizione Description	Aggancio Coupling	A mm	B mm	C Ø mm	D Ø mm
<p>NEW</p> 	M104N		Per 8 moduli For 8 modules Bt LivingLight	220	255	125	165
	MA104N	Torretta alluminio NERO terminale plastica nera cornici plastica nera BLACK aluminium turret black plastic end piece black plastic frames	Per 8 moduli For 8 modules AVE 44				
	MF104N		Per 4 moduli For 4 modules 45x45 mm				
<p>NEW</p> 	M104A3		Per 8 moduli For 8 modules Bt LivingLight	220	255	125	165
	MA104A3	Torretta alluminio BIANCO terminali plastica bianca cornici plastica bianca WHITE aluminium turret white plastic end pieces white plastic frames	Per 8 moduli For 8 modules AVE 44				
	MF104A3		Per 4 moduli For 4 modules 45x45 mm				

Sega a tazza per l'installazione della torretta estraibile
Cup saw for the installation of the pop-up turret

Articolo Item	Dimensione Dimension
MFT127	Ø127 m

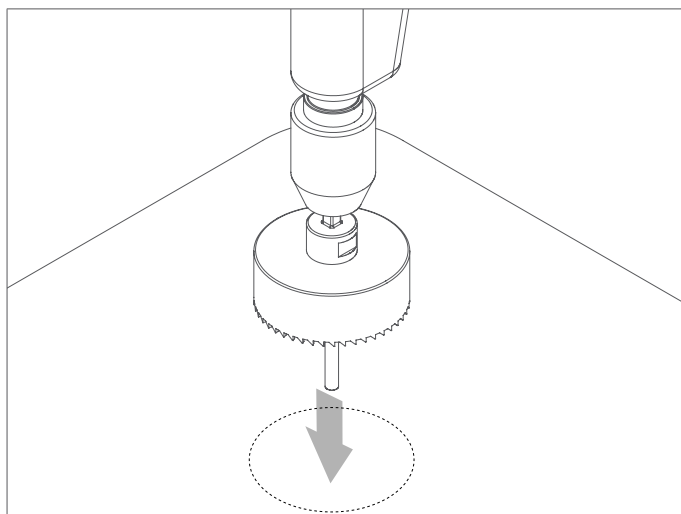

Praticare il foro sul piano utilizzando una fresa a tazza di Ø127 mm (5").
 Drill the hole in the plane using a hole saw of Ø127 mm (5")

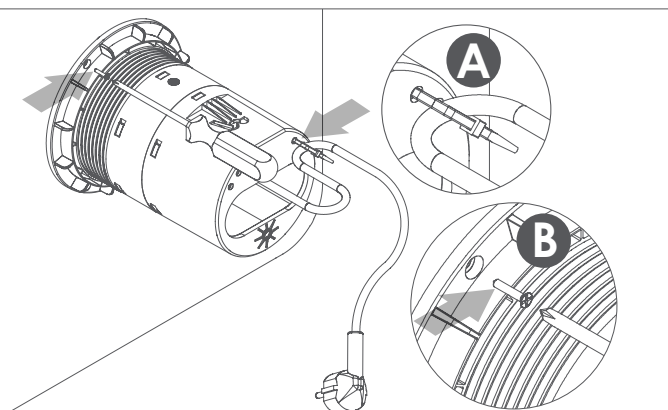

Si raccomanda di assicurare il cavo al fondo della torretta mediante una fascetta (A).
 Inoltre è possibile bloccare la ghiera di serraggio al piano con delle viti (B).
 It is recommended to secure the cable at the bottom of the turret through one cable tie (A).
 Furthermore it is possible to lock the clamping nut to the surface with screws (B).

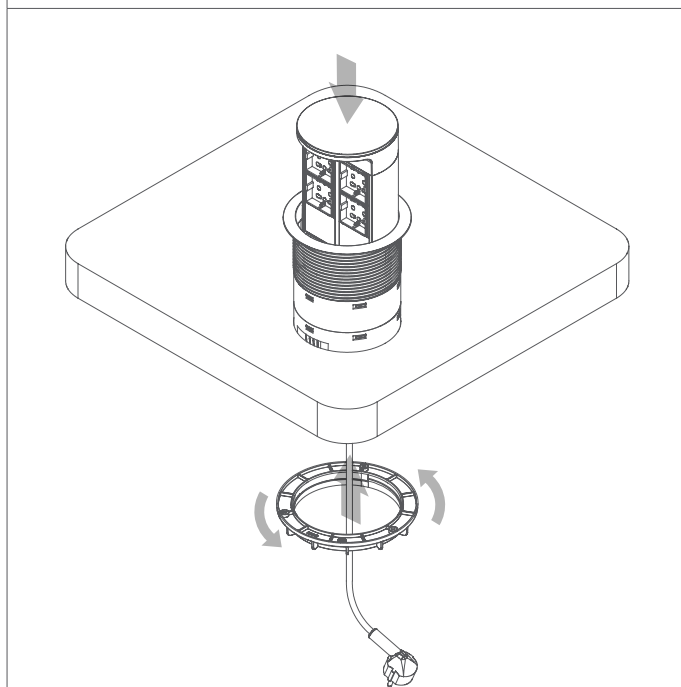

Inserire la torretta nel foro praticato sul piano ed avvitare la ghiera di serraggio.
 Insert the turret in the hole made in the plane and screw the locking ring nut.

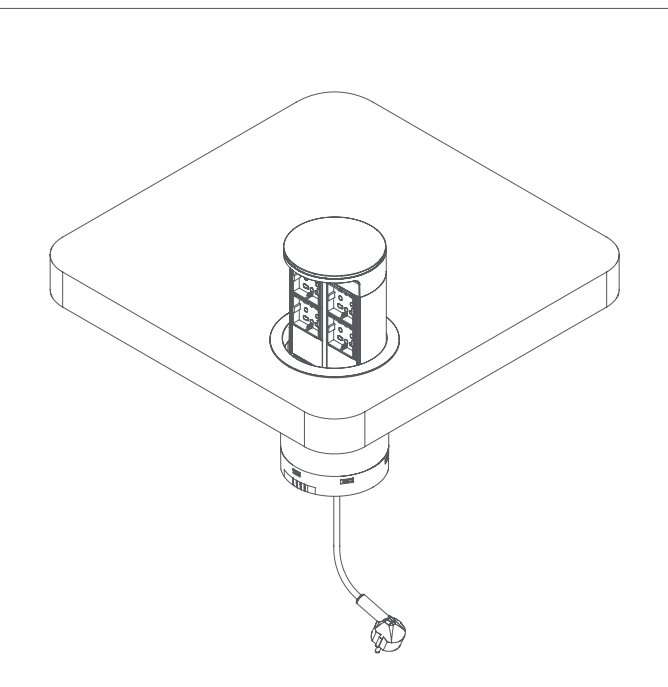

Inserire la presa nella spina, la torretta è pronta.
 Insert the plug into the plug, the turret is ready.

Luce LED con driver
LED light with driver

Articolo Item	Descrizione Description
MLED	Per l'illuminazione interna della torretta For internal lighting

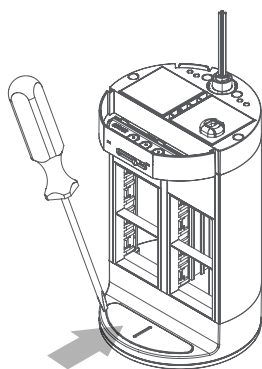

Asportare con delicatezza la piastrina di finitura con un piccolo cacciavite a taglio.

Carefully remove the finishing plate with a small screwdriver.

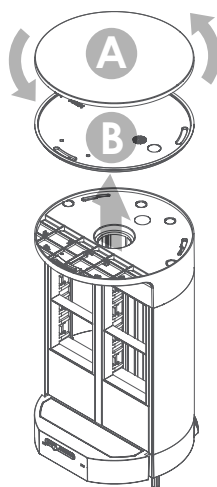

Ruotare il coperchio di finitura (A) in senso anti-orario ed asportarlo insieme alla lente (B) dalla calotta superiore.

Fare attenzione a non graffiarlo.

Turn the lid of finish (A) anti-clockwise and remove it together with the lens (B) from the upper cap.

Be careful not to scratch it.

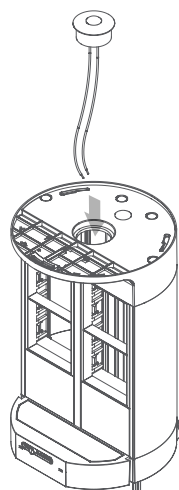

Inserire i cavi all'interno della torretta facendoli scorrere fino in fondo e assicurarsi che il led sia incassato correttamente.

Insert the cables inside the turret making them slide to the bottom and make sure that the LED is correctly recessed.

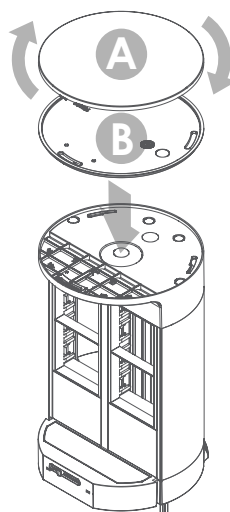

Rimontare la lente (B) sulla calotta superiore e applicare il coperchio di finitura (A) inserendo i piedi di bloccaggio all'interno delle aole e ruotare in senso orario per il bloccaggio.

Refit the lens (B) on the top cover and attach the finishing cover (A) by inserting the locking feet inside the slots and turn clockwise to lock.

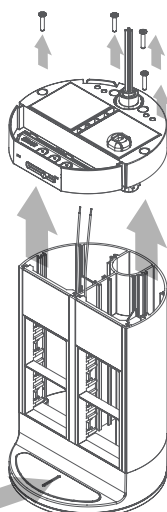

Rimontare la piastrina di finitura sulla calotta superiore ed asportare le viti e la calotta inferiore per accedere ai cavi del led.

Reassemble the finishing plate on the upper cap and remove the screws and the lower cap to access the LED cables.

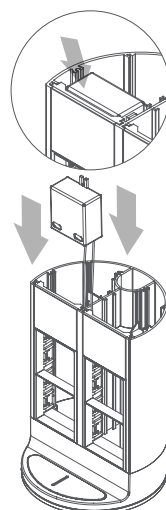

Collegare i cavi del led al driver e cablare il trasformatore. Infine inserirlo all'interno della torretta nella posizione indicata. Rimontare la calotta inferiore sulla torretta con le relative viti.

Connect the LED cables to the driver and wire the transformer. Then insert it into the turret in the indicated position. Refit the bottom part to the turret with its screws.

Funzionamento della Torretta estraibile Operation of the pop-up turret

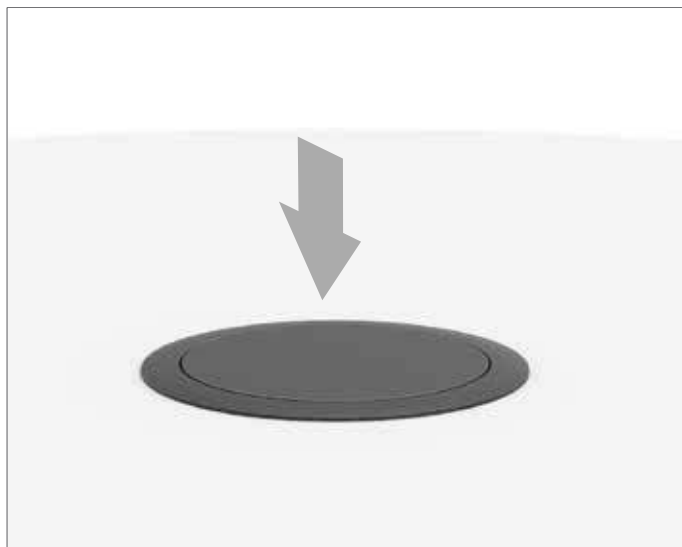

La torretta una volta montata sparisce sotto il piano su cui è montata. Per l'estrazione premere sulla parte indicata.

Once the turret is mounted it disappears under the desk on which it is mounted. To extract, press on the indicated part.



La torretta si solleverà leggermente per permettere l'estrazione manuale.

The turret will rise slightly to allow manual extraction.

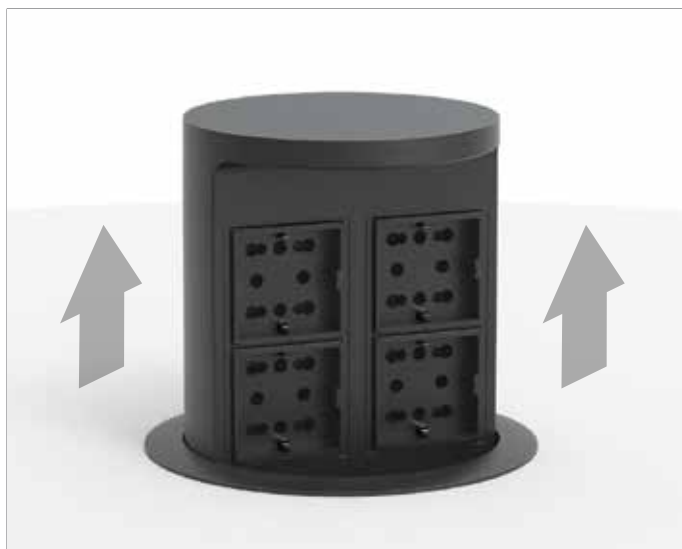

Una volta estratta la torretta è pronta all'uso.

Once removed, the turret is ready for use.

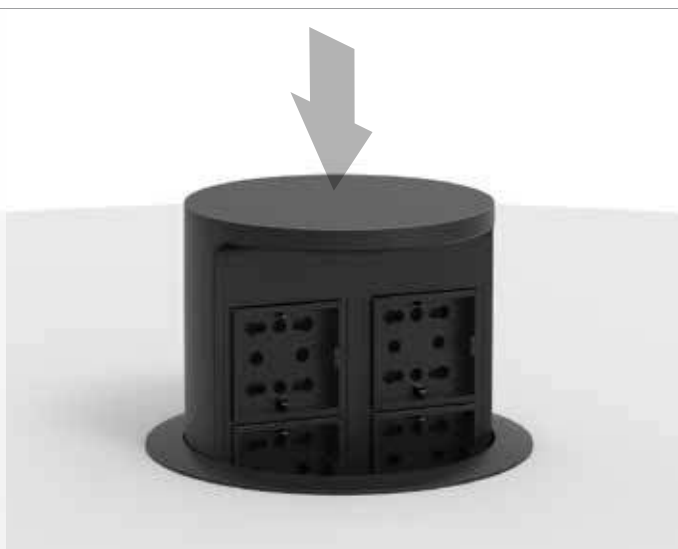

Per la chiusura premere energicamente sulla parte superiore.

To close, press firmly on the top.